

BELT GUARD KIT FOR TOP MOUNTED ELECTRICAL DRIVE ON 8" AUGER KIT #ASE-150802

1/4" x 4" long bolt
used with nut.

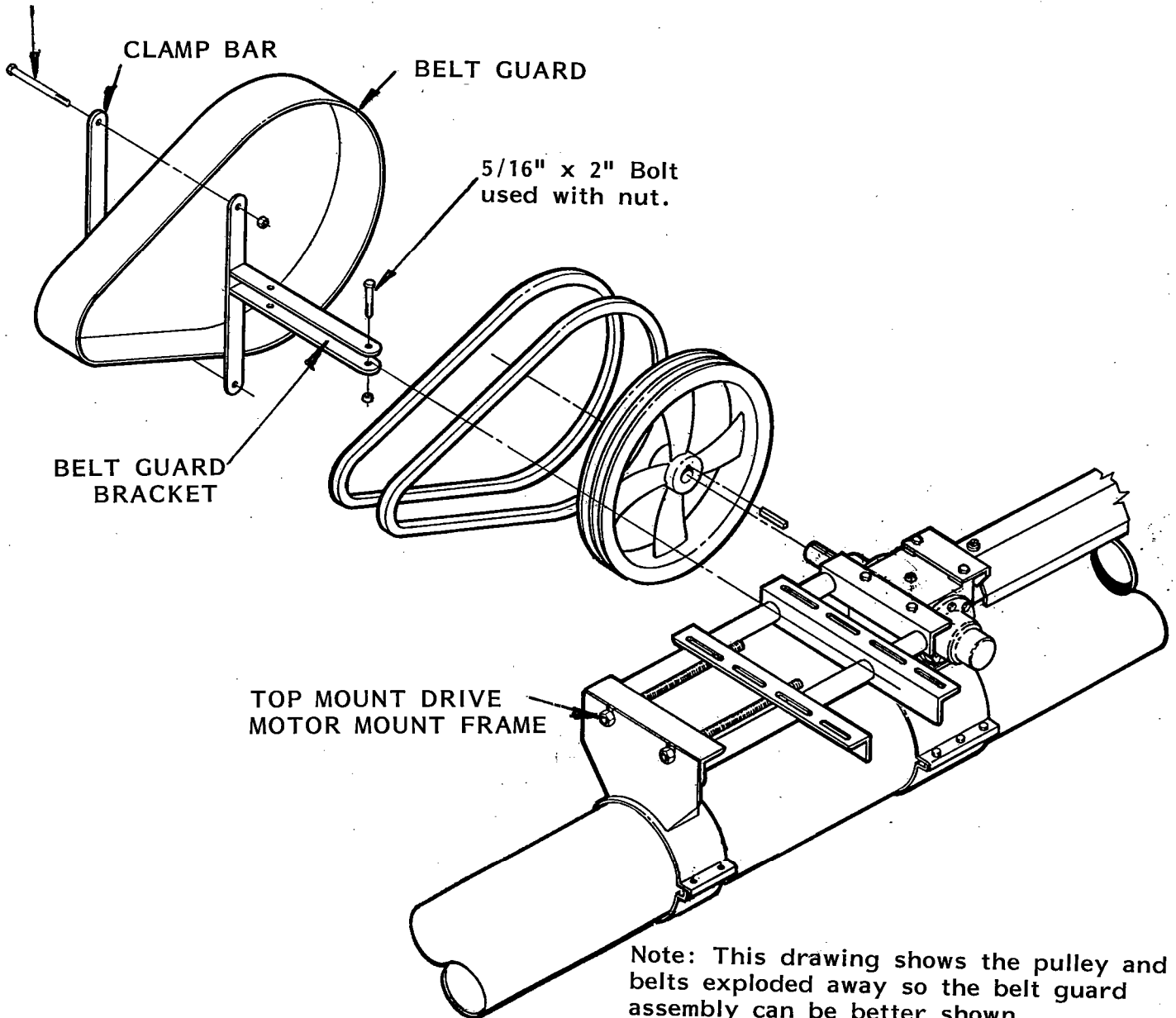

Keep all safety shields and devices in place.

If there are problems assembling the components provided in this kit, please contact us for assistance.