

BELT GUARD KIT FOR TOP MOUNTED ELECTRICAL DRIVE ON 10" AUGER KIT #ASE-150803

1/4" x 5" long bolt
used with nut.

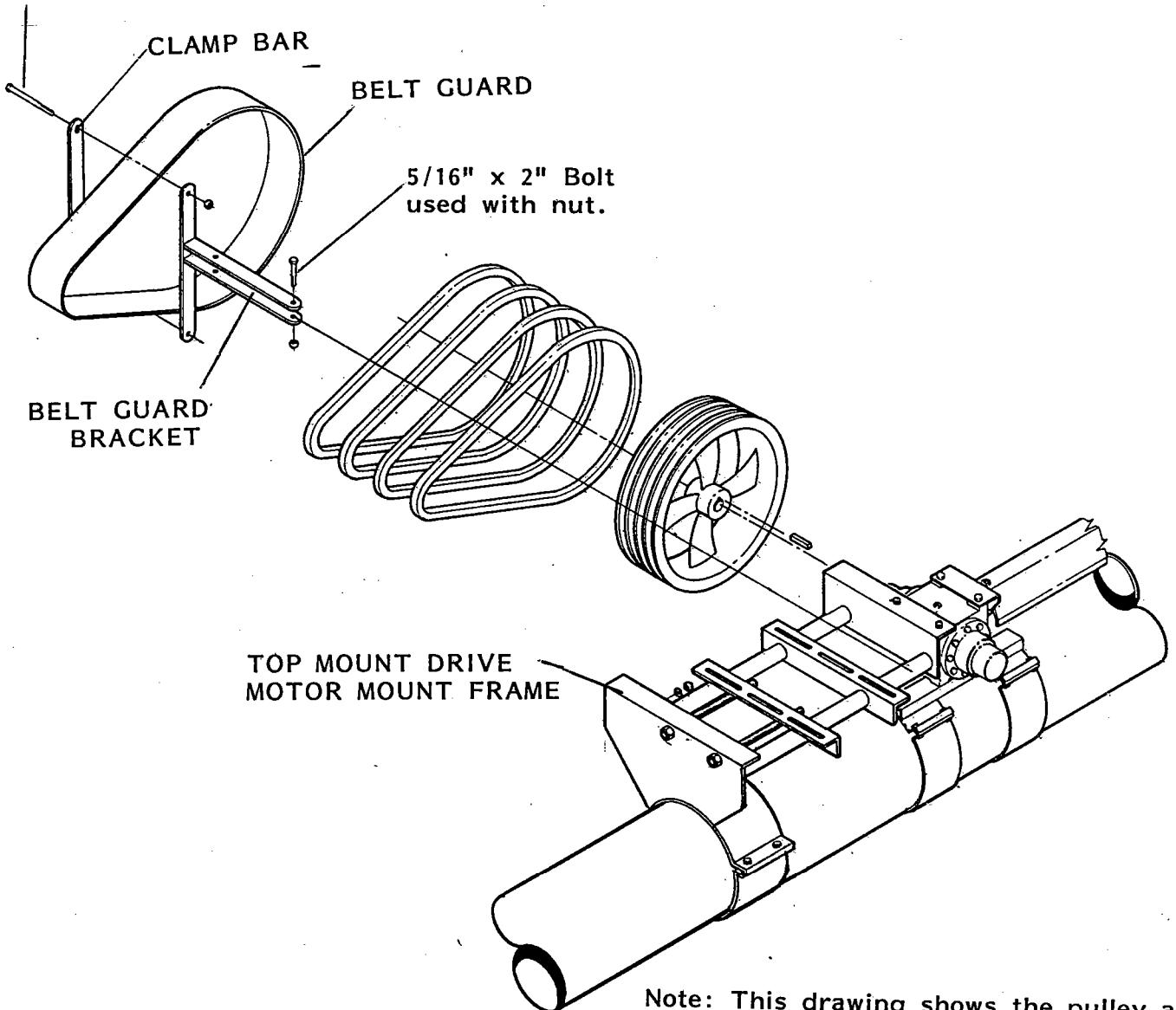

Note: This drawing shows the pulley and belts exploded away so the belt guard assembly can be better shown.



Keep all safety shields and devices in place.

If there are problems assembling the components provided in this kit, please contact us for assistance.