

## DRIVELINE TRANSPORT SUPPORT KIT #ASE-150828

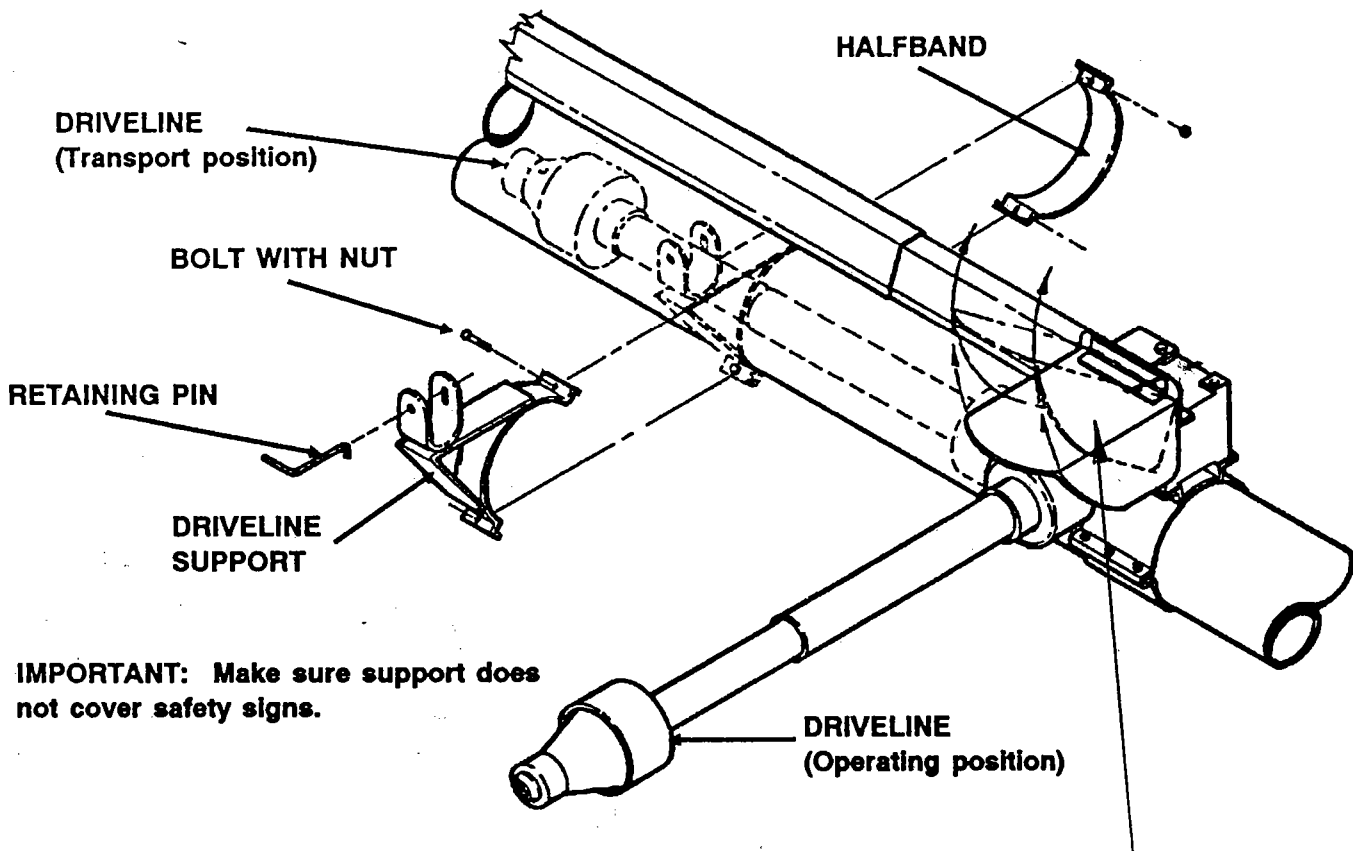

**IMPORTANT:** Make sure support does not cover safety signs.



Keep all safety shields and devices in place.

**NOTE:** Use a guard that will hinge so the Input Driveline can be placed into the transport support. A hinged guard is provided in this kit and fastens to the top of the gearbox with two 3/8" x 3/4" long bolt with lockwasher.

If there are problems assembling the components provided in this kit, please contact us for assistance.